

- **No-Contact – Hall-effect technology**
- **Wear-Free – unlimited mechanical life**
- **Simple mounting, low-profile design**
- **Measurement angle 20-360°**
- **5V or 9-30V supply options**
- **Single or dual redundant outputs**
- **Analog output – 0.5-4.5V or 0.2-4.8V**
- **PWM output – 244Hz, 500Hz or 1,000Hz**
- **Fail-safe outputs**
- **Encapsulated electronics**
- **Sealing to IP67**
- **AMP or Deutsch connector options**
- **Flying-lead option**
- **Protective cable conduit option**



The NRH271 and NRH272 is a family of no-contact, Rotary Position Sensors that offers the optimal combination of performance, safety and cost. All variants utilise proven Hall-effect, sensing technology and are accommodated in a low-profile (9.5mm) housing with a compact footprint of just 36 x 35mm.

The electrical output span can be set to correspond to rotations of 20° to 360°, and the positional information is determined by the angle of the supplied magnet relative to the sensor body. The maximum air gap between magnet and sensor is 7mm, while concentric offsets of up to 2mm can be tolerated with minimal impact on output linearity. The magnet can be supplied in a convenient carrier, housed in a bolt, as a plug or loose.

A choice of power supply options are available – one for connection to a regulated 5V supply and the other to a varying voltage in the range of 9-30V, such as a vehicle's battery. The NRH271 range has a single output, while the NRH272 has a second, redundant output. In addition, the NRH272 contains two completely independent measuring circuits, each with its own power supply, meaning high-

performing, safety-critical applications can easily be addressed. Furthermore, both models contain on-board diagnostic functions that mean the outputs can be put into safe, pre-defined states should an internal sensor error be detected. The versatile, factory-programmable electronics can be easily set to one of two analog voltage output ranges or one of three PWM frequencies. In addition, the polarities of each of the analog outputs can be independently set.

A fully encapsulated design offers exceptional levels of performance with respect to water and dust, shock, vibration and temperature, meaning the sensor is ideal for use in hostile, on- and off-highway vehicle environments.

Connection options are industry-standard AMP Superseal (IP68 rated) or Deutsch DT04 series (IP67 rated) connectors, or simple flying leads for customer termination. The sensor can also be supplied with a protective conduit for the cabling.



## CONTENTS

<b>Configuration &amp; Ordering Codes</b> .....	<b>3</b>
Measurement Angle .....	3
Supply.....	3
Output.....	3
Direction .....	4
Magnet.....	4
Cable.....	4
Connector .....	5
<b>Installation</b> .....	<b>6</b>
Mechanical .....	6
Sensor .....	6
Magnet.....	7
Electrical Connections.....	8
Flying Leads (C0) .....	8
Deutsch DT04 (C1) .....	8
AMP Superseal (C2).....	9
<b>Specifications</b> .....	<b>10</b>
Electrical.....	10
Voltage Outputs .....	11
PWM Outputs.....	12
Mechanical .....	12
Environmental .....	13

© 2023 Curtiss-Wright. All rights reserved.

Curtiss-Wright accepts no responsibility for possible errors in catalogs, brochures and other printed material. Curtiss-Wright reserves the right to alter its products without prior notice. This also applies to products already Ordered provided that such alterations can be made without affecting agreed specifications. All trademarks in this material are properties of their respective owners.



## CONFIGURATION & ORDERING CODES

NRH27Y-XXX-XX-XX-X-X-XXX-XX

Y = 1 for NRH271

Y = 2 for NRH272

Type	Measurement Angle	Supply	Output	Direction	Magnet	Cable	Connector
NRH27Y	XXX	XX	XX	X	X	XXX	XX
	XXX	V1	A1	1	O	P2C	C0
V2		A5	2	B	P2N	C1	
			P1	3	P		C2
			P2	4	M		
			P3	5			
				6			

### MEASUREMENT ANGLE

NRH27Y-XXX-XX-XX-X-X-XXX-XX

Code	Description
XXX	20-360° in 1° increments

OEM options exist for independent measurement angles on each output of the NRH272. Please contact your representative for more information.

### SUPPLY

NRH27Y-XXX-XX-XX-X-X-XXX-XX

Code	Supply Voltage
V1	5Vdc $\pm$ 0.5Vdc
V2	5Vdc $\pm$ 0.5Vdc and 9-30Vdc unregulated – auto-selects

### OUTPUT

NRH27Y-XXX-XX-XX-X-X-XXX-XX

Code	Description
A1	Analog voltage: 10-90% of 5V supply or 0.5-4.5V of 9-30V supply
A5	Analog voltage: 4-96% of 5V supply or 0.2-4.8V of 9-30V supply
P1	PWM: 244Hz
P2	PWM: 500Hz
P3	PWM: 1kHz



**DIRECTION**

NRH27Y-XXX-XX-XX-X-X-XXX-XX

Code	Description
1	NRH271: clockwise
2	NRH271: anti-clockwise
3	NRH272: both clockwise
4	NRH272: both anti-clockwise
5	NRH272: Output 1 clockwise, Output 2 anti-clockwise
6	NRH272: Output 1 anti-clockwise, Output 2 clockwise

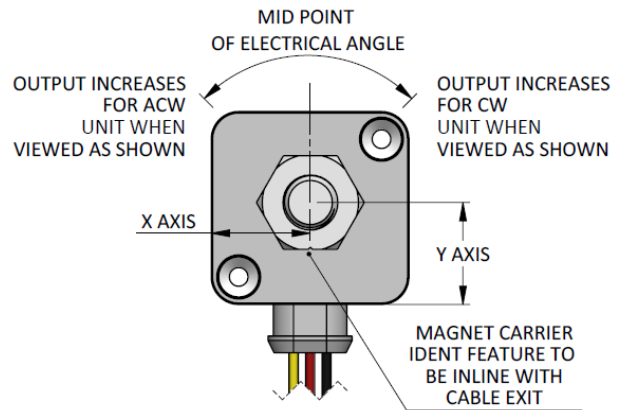

**MAGNET**

NRH27Y-XXX-XX-XX-X-X-XXX-XX

Code	Description
O	Molded carrier
B	Bolt-type carrier
P	Plug-type carrier
M	Magnet only

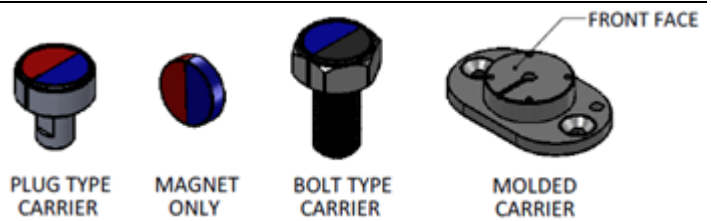

**CABLE**

NRH27Y-XXX-XX-XX-X-X-XXX-XX

Code	Description
P2C	0.2m length with protective conduit tube (for C1 and C2 connector options)
P2N	0.2m length, no conduit tube (for no connector option, C0)



**CONNECTOR**

NRH27Y-XXX-XX-XX-X-X-XXX-~~XX~~

---

<b>Code</b>	<b>Description</b>
C0	No connector, 3- or 6-way flying leads
C1	Deutsch DT04
C2	AMP Superseal

---



## INSTALLATION

### MECHANICAL

#### Sensor

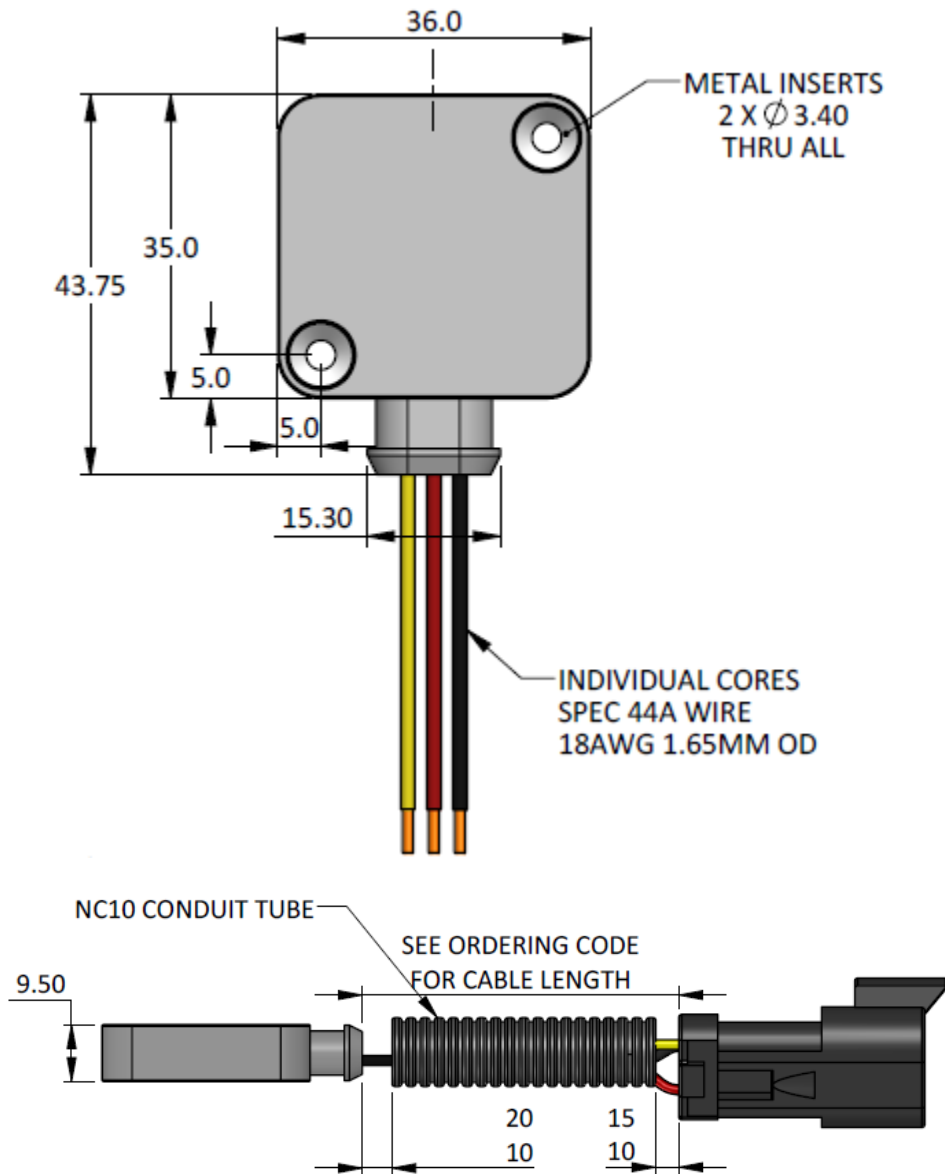



**Magnet**

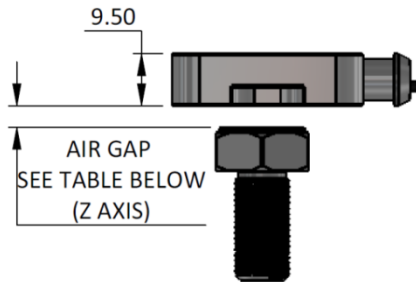

Magnet Type	Air Gap
BOLT & PLUG TYPE	2-7mm
MOLDED CARRIER	1.5-6.5mm from front face of carrier
MAGNET ONLY	3-8mm

**NOTES**

All stated specifications are based on a nominal air gap of 3.5mm. Per the table above, other air gaps are possible but some specifications may vary. Please consult Curtiss-Wright for further details.

If the unit is operated when the magnet is outside the recommended air gap, the output will not meet specification. If the magnet is absent, the output will default to <0.1Vdc or a 0% PWM duty cycle.

**Molded Carrier**

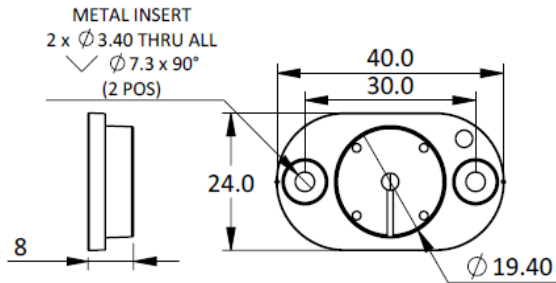

**Bolt Type**

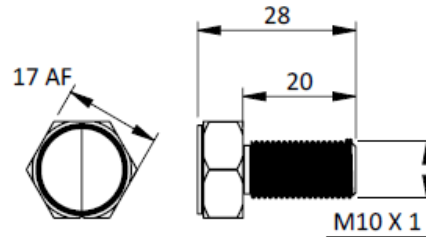

**Plug Type**

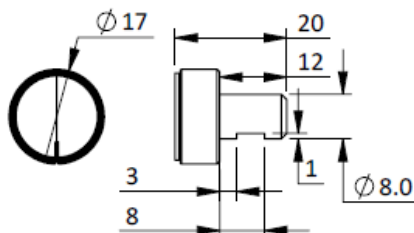

**Magnet Only**

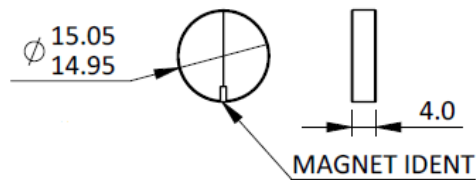

**ELECTRICAL CONNECTIONS****Flying Leads (C0)**

Color	Function	
RED	NRH271: Vsupply	NRH272: Vsupply 1
BLACK	NRH271: GND (0V)	NRH272: GND (0V) 1
YELLOW	NRH271: Output	NRH272: Output 1
BLUE		NRH272: Vsupply 2
GREEN		NRH272: GND (0V) 2
WHITE		NRH272: Output 2

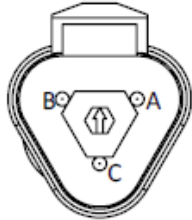
**Deutsch DT04 (C1)****NRH271**

Deutsch DT04 3P-CE03 with gold contact 0460-202-1631

Mating Part No: DT06-3S-\*\*\*\* (plug) &amp; 0462-201-1631 (pins)

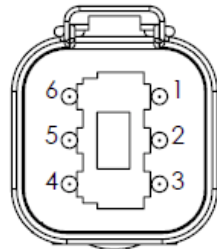
**NRH272**

Deutsch DT04 6P-CE03 with gold contact 0460-202-1631

Mating Part No: DT06-6S-\*\*\*\* (plug) &amp; 0462-201-1631 (pins)

Pin	Function	
1/A	NRH271: GND (0V)	NRH272: GND (0V) 1
2/B	NRH271: Output	NRH272: Vsupply 1
3/C	NRH271: Vsupply	NRH272: Output 1
4		NRH272: GND (0V) 2
5		NRH272: Vsupply 2
6		NRH272: Output 2





**AMP Superseal (C2)**

**NRH271**

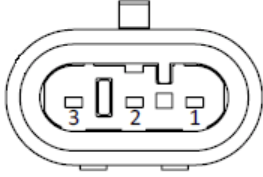

AMP 1.5 Superseal 282105-1

Mating Part No: 282087-X (plug) & 183025-1 (pins)

**NRH272**

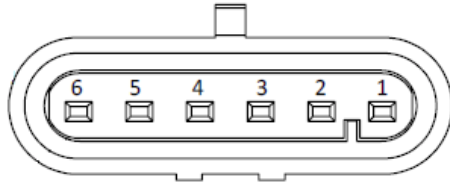

AMP 1.5 Superseal 282108-1

Mating Part No: 282090-X (plug) & 183025-1 (pins)

---

<b>Pin</b>	<b>Function</b>	
1	NRH271: Output	NRH272: GND (0V) 1
2	NRH271: Vsupply	NRH272: Vsupply 1
3	NRH271: GND (0V)	NRH272: Output 1
4		NRH272: GND (0V) 2
5		NRH272: Vsupply 2
6		NRH272: Output 2

---



## SPECIFICATIONS

### ELECTRICAL

MEASUREMENT RANGE	20-360° in 1° increments
SUPPLY VOLTAGE	5Vdc ±0.5Vdc or 5Vdc ±0.5Vdc and 9-30Vdc unregulated – auto-selects
SUPPLY CURRENT	NRH271: <12.5mA NRH272: <25mA
SUPPLY REVERSE POLARITY PROTECTION	Yes
SHORT-CIRCUIT PROTECTION TO GND	Yes
SHORT-CIRCUIT PROTECTION TO SUPPLY	When used with 5V supply only
OVER-VOLTAGE PROTECTION	Up to 12Vdc @ 5V supply
POWER-ON SETTLEMENT	<1s
RESOLUTION	12-bit (0.025% of measurement range)
LINEARITY (ABSOLUTE)	±0.4%

Linearity versus magnetic misalignment

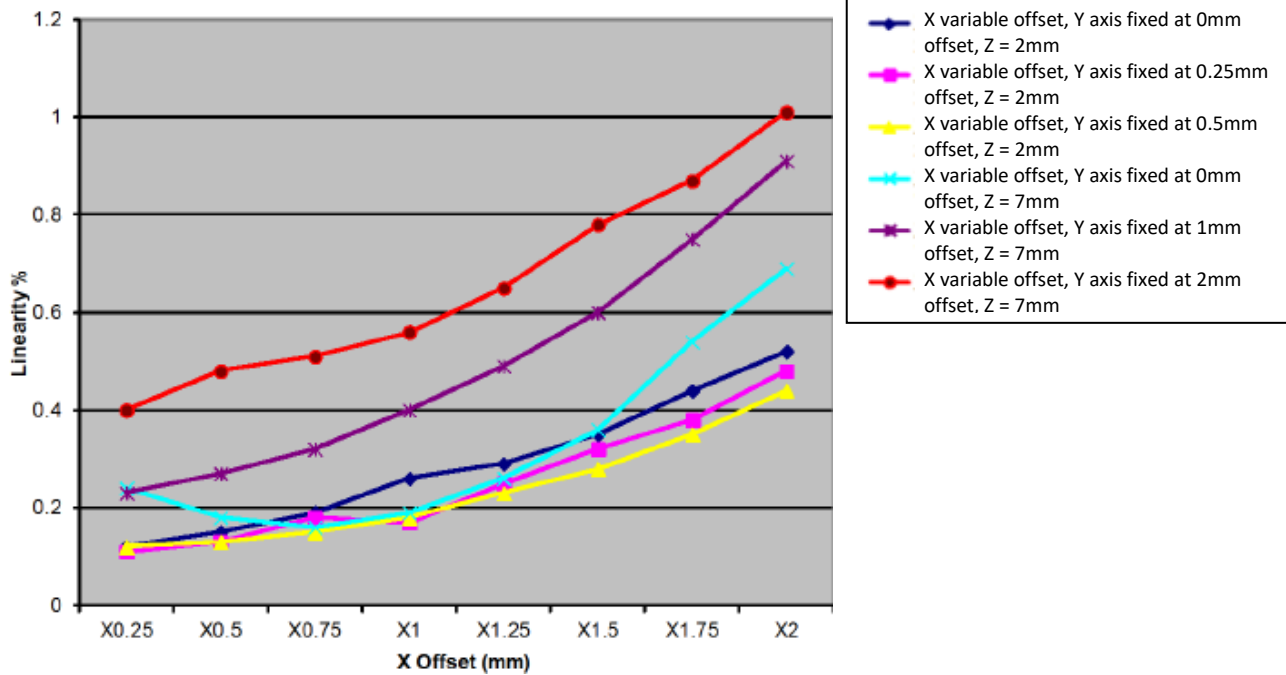

TEMPERATURE COEFFICIENT	<30ppm/°C
-------------------------	-----------



### VOLTAGE OUTPUTS

---

OUTPUT RANGE A1 @ 5Vdc SUPPLY	10-90% ±1% of Vsupply over measurement range
OUTPUT RANGE A1 @ 9-30Vdc SUPPLY	0-5-4.5V ±3% absolute
MONOTONIC RANGE	5%/0.25V to 95%/4.75V nominal
OUTPUT RANGE A5 @ 5Vdc SUPPLY	4-96% ±1% of Vsupply over measurement range
OUTPUT RANGE A5 @ 9-30Vdc SUPPLY	0.2-4.8V ±3% absolute
MONOTONIC RANGE	2%/0.1V to 98%/4.9V nominal

---

Voltage output law examples

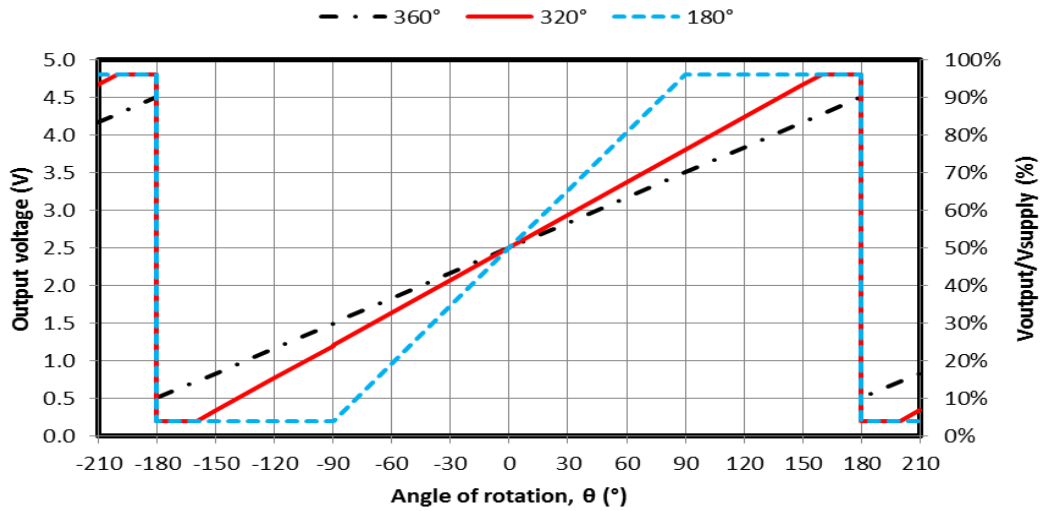

---

LOAD RESISTANCE	10k $\Omega$ min. (resistive to GND)
OUTPUT NOISE	<1mV rms
INPUT/OUTPUT DELAY A1 & A5	<2ms

---

**PWM OUTPUTS**

PWM FREQUENCY	244Hz, 500Hz or 1kHz $\pm 20\%$
PWM LEVELS @ 5Vdc SUPPLY	0V and $V_{supply} \pm 1\%$
PWM LEVELS @ 9-30Vdc SUPPLY	0V and 5V $\pm 3\%$ nominal
DUTY CYCLE	10-90% over measurement range
MONOTONIC RANGE	5-95% nominal
LOAD RESISTANCE	10k $\Omega$ min. (resistive to GND)
RISE/FALL TIME	<15 $\mu$ s typical

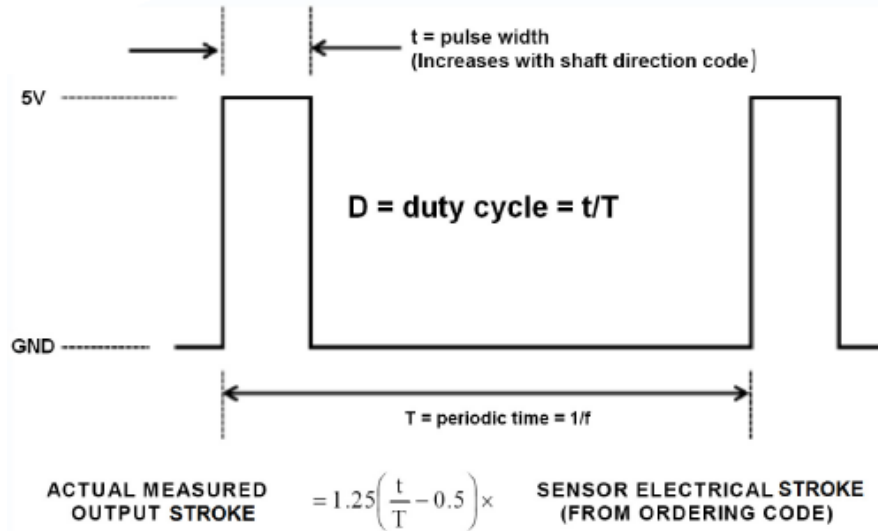
**MECHANICAL**

MECHANICAL ANGLE	360° continuous
MAXIMUM OPERATING SPEED	3600°/s
WEIGHT	<100g
MOUNTING	2x $\varnothing 3.4$ mm holes with $\varnothing 7.3$ mm x 90° CSK
CABLE	Spec 44A wires 18AWG 1.65mm OD

**ENVIRONMENTAL**

---

OPERATING TEMPERATURE RANGE	-40°C to 140°C (-40°C to 120°C if conduit fitted)
STORAGE TEMPERATURE RANGE	-55°C to 140°C
SEALING	Sensor body IP69K AMP connector IP68 when fully mated Deutsch connector IP67 when fully mated
VIBRATION	EN 60068-2-64:1995 section 8.4 (31.4gn rms) 20-2000Hz random
SHOCK	3m drop onto concrete and 2500g
LIFE	Virtually infinite
MTTFd	> 600 years
ELECTROMAGNETIC INTERFERENCE	EN 61000-4-3:1999 to 100V/m 80-1000MHz & 1.4-2.7GHz
SALT SPRAY	BS EN 60068-2-52 TEST KB SEVERITY 2

---

**IMPORTANT INFORMATION**

Whilst Curtiss-Wright Industrial Division - Penny & Giles has designed this sensor to meet a range of applications it is the responsibility of the customer to ensure it meets their specific requirement.

Penny & Giles Controls Ltd makes no warranty or representation in respect of product fitness or suitability for any particular design application, environment, or otherwise, except as may subsequently be agreed in contract for the sale and purchase of products. Customers should therefore satisfy themselves of the actual performance requirements and subsequently the product's suitability for any particular design application and the environment in which the product is to be used.

Continual research and development may require change to products and specification without prior notification.

All trademarks acknowledged.