

- **Robust design for arduous in-cab applications**
- **Return-to-center**
- **Optional lever actuator profile**
- **Low under-panel depth of 23mm**
- **Hall-effect sensor technology**
- **Rated for 3 million cycles of life**
- **Dual-redundant electronic architecture**
- **Outputs with sense and voltage span options**
- **Dual supply to ensure a high level of signal integrity**
- **Designed to allow contamination (liquid or dust) to pass through the mechanism without causing any damage**
- **Electronics sealed to IP67**



The JC050 is a roller for use in joystick grips and other in-cab human-machine interfaces. A robust, return-to-center mechanism provides movement over a range of $\pm 37^\circ$, with the thumbwheel having an option of a lever profile to ease operation. A compact mechanical design means the required under-panel space is just 23mm.

The roller utilizes non-contacting, Hall-effect sensing technology that eliminates contact wear and provides for long-life integrity of the output signal, giving rise to a minimum operating life of 3 million cycles.

Safety is enhanced via a fully dual-redundant electronic architecture made up of two power supplies and two sensing circuits, the outputs of which can be set to positive or negative ramps or a combination of both. Electronic robustness is assured with the enclosure sealing rated to IP67.





CONTENTS

Contents2

Configuration & Ordering Codes3

 Output sense3

 output span.....5

 wheel type5

 cable type5

 Cable length5

 number of cables5

 wheel color6

 bezel color6

Installation7

 Mechanical7

 Dimensions7

 Panel Cut-out Details8

 Panel Mounting Details - standard8

 Electrical Connections9

 Electrical Connector details - Molex 35507-03009

Specifications.....10

 Electrical.....10

 Mechanical10

 Environmental & legislative.....11

© 2021 Curtiss-Wright. All rights reserved.

Curtiss-Wright accepts no responsibility for possible errors in catalogs, brochures and other printed material. Curtiss-Wright reserves the right to alter its products without prior notice. This also applies to products already ordered provided that such alterations can be made without affecting agreed specifications. All trademarks in this material are properties of their respective owners.



CONFIGURATION & ORDERING CODES

JC050-GEN-XX-XX-X-XX-XXXX-X-X-X

Type	Output Sense	Output Span	Wheel Type	Cable Type	Cable Length	Number of Cables	Wheel Color	Bezel Color
JC050-GEN	XX	XX	X	XX	XXXX	X	X	X
	PN	10	R	SD	F055	3	1	1
	PP	20	T	HC	F350	4		
	P0					6		
	FG							

SD	C205	3	Specific Cable/Connector option
-----------	-------------	----------	--

OUTPUT SENSE

JC050-GEN-**XX**-XX-X-XX-XXXX-X-X-X

Code	Description
PN	Output 1: Positive slope Output 2: Negative slope
PP	Output 1: Positive slope Output 2: Positive slope
P0	Output 1: Positive slope Output 2: No Output
FG	Output 1: Flat with Positive slope Output 2: Negative slope with Flat

PN

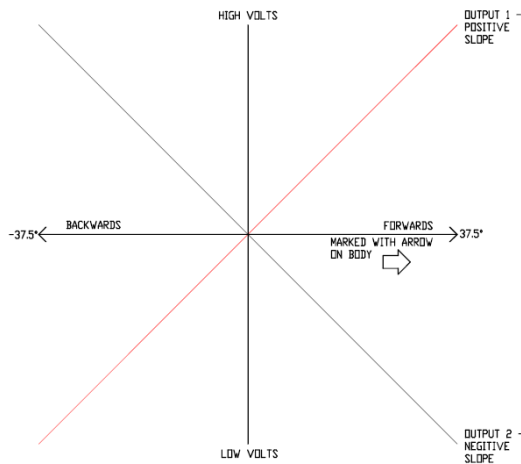



PP

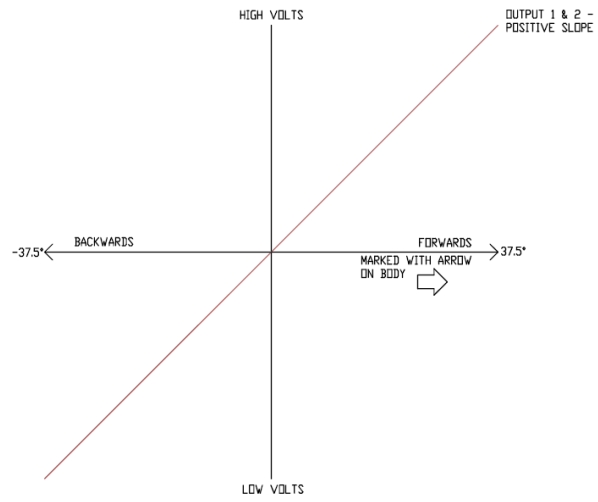

P0

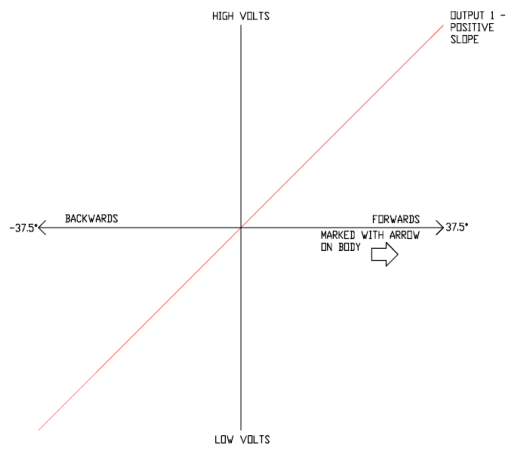

FG

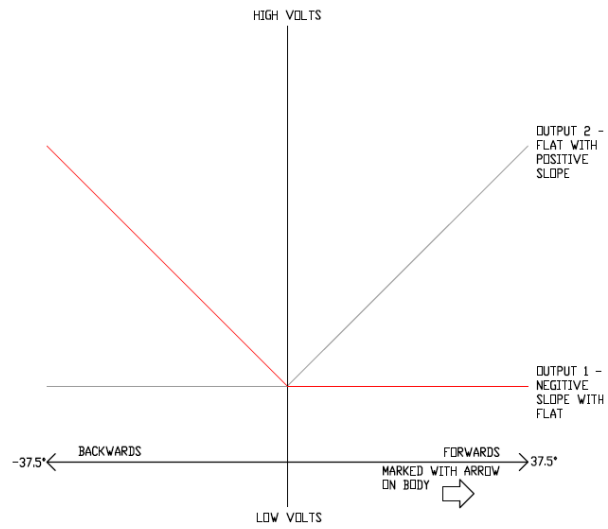



OUTPUT SPAN

JC050-GEN-XX-~~XX~~-X-XX-XXXX-X-X-X

Code	Description
10	10% to 90% of 5V supply voltage (0.5V to 4.5V)
20	20% to 80% of 5V supply voltage (1.0V to 4.0V)

The Output Range (at ends of travel) is based on a regulated 5V supply. The general output tolerance is $\pm 2\%$ of V_s

WHEEL TYPE

JC050-GEN-XX-XX-~~X~~-XX-XXXX-X-X-X

Code	Description
R	Roller Wheel
T	Thumb Wheel

CABLE TYPE

JC050-GEN-XX-XX-X-~~XX~~-XXXX-X-X-X

Code	Description
SD	Standard Duty
HC	High Cycle

The Standard Duty cable is recommended for fixed cable routing applications such as panel installations; available for F055 and C205 cable length options

The High Cycle cable is recommended for dynamic application such as joystick grips; available for F350 option

CABLE LENGTH

JC050-GEN-XX-XX-X-XX-~~XXXX~~-X-X-X

Code	Description
F055	Flying Lead with 55mm cable length – SD cable type
C205	Flying Lead with 205mm cable length and 3-way Molex 35507-0300 Connector – SD cable type
F350	Flying Lead with 350mm cable length – HC cable type









NUMBER OF CABLES

JC050-GEN-XX-XX-X-XX-XXXX-~~X~~-X-X

Code	Description
3	Three Cable – Single output
4	Four Cable – Dual Output with Common Supply
6	Six Cable – Dual Output with Independent Supplies









**WHEEL COLOR**

JC050-GEN-XX-XX-X-XX-XXXX-X-X-X

Code	Color Description	Applicable RAL Number	Availability
1	 Black	RAL 9005	Standard and available
2	 Grey	RAL 7042	Special order with minimum order quantity
3	 White	RAL 9003	Special order with minimum order quantity
4	 Yellow	RAL 1023	Special order with minimum order quantity
5	 Orange	RAL 2007	Special order with minimum order quantity
6	 Red	RAL 3028	Special order with minimum order quantity
7	 Purple	RAL 4006	Special order with minimum order quantity
8	 Blue	RAL 5010	Special order with minimum order quantity
9	 Green	RAL 6038	Special order with minimum order quantity

BEZEL COLOR

JC050-GEN-XX-XX-X-XX-XXXX-X-X-X

Code	Color Description	Applicable RAL Number	Availability
1	 Black	RAL 9005	Standard and available
2	 Grey	RAL 7042	Special order with minimum order quantity
3	 White	RAL 9003	Special order with minimum order quantity
4	 Yellow	RAL 1023	Special order with minimum order quantity
5	 Orange	RAL 2007	Special order with minimum order quantity
6	 Red	RAL 3028	Special order with minimum order quantity
7	 Purple	RAL 4006	Special order with minimum order quantity
8	 Blue	RAL 5010	Special order with minimum order quantity
9	 Green	RAL 6038	Special order with minimum order quantity



INSTALLATION

MECHANICAL

Dimensions

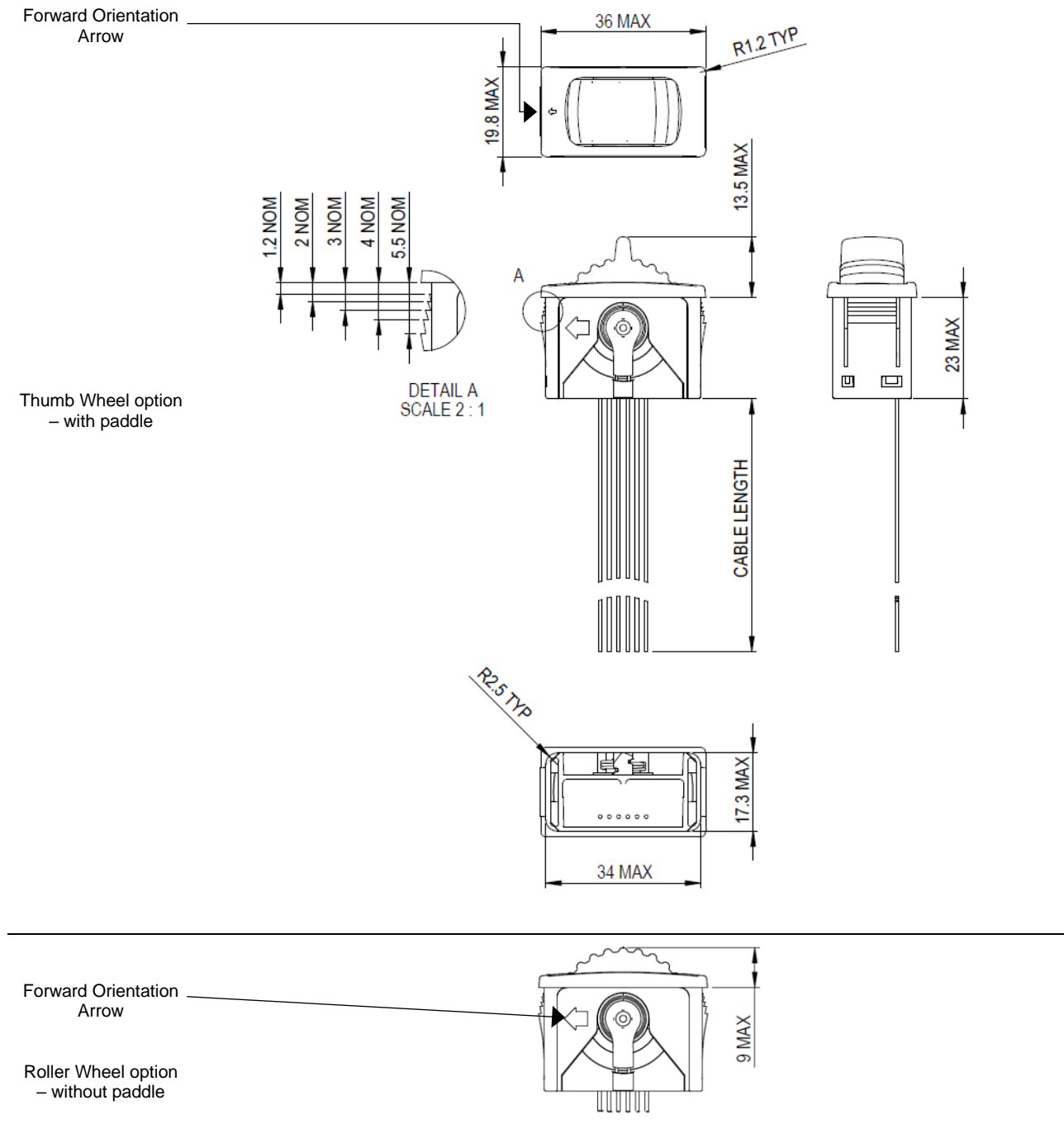

Panel Cut-out Details

The following details show the hole that should be cut in the mounting panel

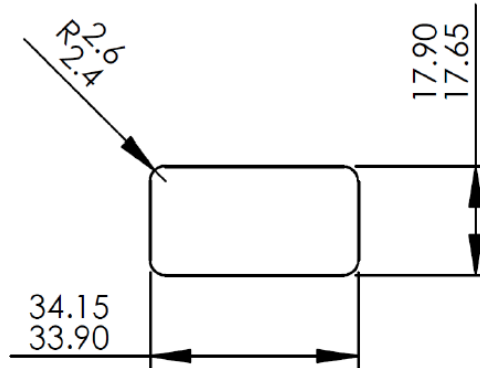

Curtiss Wright recommend that a panel thickness of 1.1mm to 5.4mm is used

The JC050 is a press fit into the panel and does not require any additional fixings

Panel Mounting Details - standard

There is a minimal spacing between two JC050 rollers to ensure there isn't any influence on one rollers output from the other rollers magnet. In a standard mounting configuration the minimal gap is detailed below:

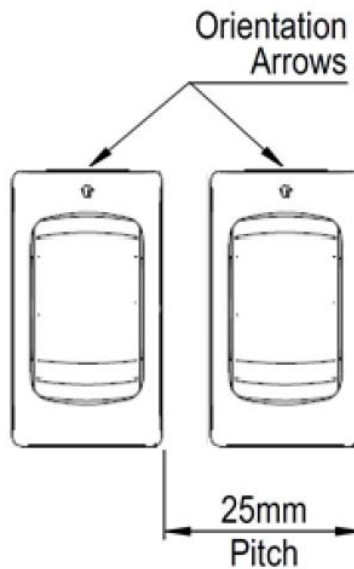



ELECTRICAL CONNECTIONS

The JC050 is supplied with up to 6 cables with the colors and functions below

The SD Cables are size 28 AWG (7/0.120), PTFE insulated and unscreened

The HC Cables are size 30 AWG (19/0.060) PTFE insulated and unscreened

Cable Color	Molex Connector Pin	Function
Yellow	Pin 2	Output 1 Signal
Black	Pin 3	0V Output 1 Sensor
Red	Pin 1	+5V to Output Sensor 1
Violet		+5V to Output Sensor 2
Green		0V Output 2 Sensor
Blue		Output 2 Signal

ELECTRICAL CONNECTOR DETAILS - MOLEX 35507-0300

This connector is only available as a 3-way option and with the 205 mm long SD type cable

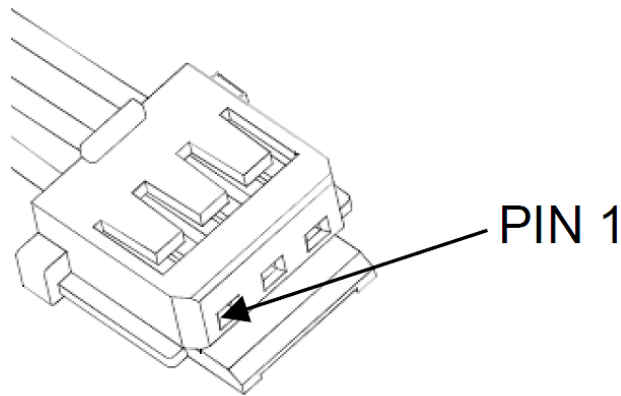



SPECIFICATIONS

ELECTRICAL

SUPPLY VOLTAGE	5Vdc \pm 0.5Vdc
OUTPUT VOLTAGE	10% to 90% or 20% to 80% \pm 2% of Supply Voltage
CENTER REFERENCE	48% to 52% of Supply Voltage
TOLERANCE OF OUTPUT VOLTAGE AFTER LIFE (including temperature effects)	End of travel positions: \pm 3% Center position: \pm 3%
OUTPUT SENSE	The dual outputs can be configured to have positive ramps, a combination of positive and negative ramps or full voltage range over half travel from each sensor with constant (low end of selected voltage range) output in the other half travel
CURRENT CONSUMPTION	< 19mA
NON-LINEARITY	< \pm 0.4%
TRACKING ERROR	\pm 2%
POWER ON SETTLEMENT TIME	Up to 15mS
OVER VOLTAGE PROTECTION	Up to 20V (-40° to +80°C)
SHORT CIRCUIT PROTECTION	Output to ground and output to supply
SUPPLY REVERSE POLARITY PROTECTION	-10Vdc (Continuous)
CONNECTION	3, 4 or 6-way flying lead based on input/output requirements

MECHANICAL

BREAKOUT FORCE	12.2 Nm
OPERATING FORCE AT END OF TRAVEL	24.4 Nm
MAXIMUM LOAD ON ROLLER	200N downward 0.4Nm torque
TYPICAL MAXIMUM VERTICAL IMPACT ENERGY CAPABILITY	1 Joule
MECHANICAL ANGLE	\pm 37°
MECHANICAL LIFE	3 million cycles
WEIGHT	14.6g nominal



ENVIRONMENTAL & LEGISLATIVE

OPERATING TEMPERATURE	Temperature Cycle: Thermal Shock: Temperature & Humidity:	BS EN60068-2-14 BS EN60068-2-14 BS EN60068-2-14	-40°C to 85°C
STORAGE TEMPERATURE	Cold Test: Dry Heat:	BS EN60068-2-1 BS EN60068-2-2	-40°C to 85°C
ENVIRONMENTAL PROTECTION	The roller has a design where contamination (liquid or dust) can pass through the mechanism without causing any damage and an IP67 protection of the electronics		
EMC IMMUNITY LEVEL	BCI- ISO 11432-4: 2005 Free Field- ISO 11452-2: 2004	20 – 800MHz 100V/m, 400-2GHz	
EMI	ISO14982: 2009	ECE Reg. 10.04 Annex 7	
VIBRATION (SINUSOIDAL)	EN 60068-2-6: 2008	3gn, 10-200Hz, 1h per axis	
VIBRATION (RANDOM)	EN 60068-2-64: 2008	3.6gn, 10-200Hz, 2h per axis	
BUMP	EN 60068-2-27: 2008	25gn, 10ms, 500 bumps in each of 6 directions	
FREE-FALL DROP	EN 60068-2-32: 1993	1.0m at level C, 1.2m at level E	
SHOCK	EN 60068-2-27: 2008	50g, 6ms, half sine, 3 shocks in each of 6 directions	
SALT SPRAY	EN 60068-2-11: 1999	96 hours	
MTTFd	>700 years		

IMPORTANT INFORMATION

Whilst Curtiss-Wright Industrial Division - Penny & Giles has designed this joystick to meet a range of applications it is the responsibility of the customer to ensure it meets their specific requirement.

Penny & Giles Controls Ltd makes no warranty or representation in respect of product fitness or suitability for any particular design application, environment, or otherwise, except as may subsequently be agreed in contract for the sale and purchase of products. Customers should therefore satisfy themselves of the actual performance requirements and subsequently the product's suitability for any particular design application and the environment in which the product is to be used.

Continual research and development may require change to products and specification without prior notification. All trademarks acknowledged.